

Phased-Array Antenna Beam Squinting Related to Frequency Dependency of Delay Circuits

Seyed Kasra Garakoui, Eric A.M. Klumperink, Bram Nauta, Frank E. van Vliet

*ICD Group, EWI Faculty, The University of Twente
Enschede, The Netherlands*

Abstract—Practical time delay circuits do not have a perfectly linear phase-frequency characteristic. When these delay circuits are applied in a phased-array system, this frequency dependency shows up as a frequency dependent beam direction (“beam squinting”). This paper quantifies beam squinting for a linear one-dimensional phased array with equally spaced antenna elements. The analysis is based on a (frequency-dependent) linear approximation of the phase transfer function of the delay circuit. The resulting relation turns out to be invariant for cascaded cells. Also a method is presented to design time-delay circuits to meet a maximum phased-array beam squinting requirement.

Index terms: Phased-arrays, Beam-forming, Beam squint, Beam pointing, Analog delay, True time delay, Phase-shifter, $f_{\varphi=0}$.

I. INTRODUCTION

Phased-array antenna systems have wide range of applications for example in radar, imaging and communication systems [1], [2], [3]. The design of phased array systems is challenging, especially when a wide band of operation is required. An important phenomenon that can limit bandwidth in phased array antenna systems is beam squinting [1], i.e. the changing of the beam direction as a function of the operating frequency, see figure 1.

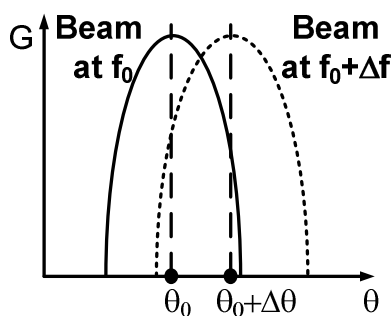

Figure 1: Antenna pattern illustrated beam squint

Beam squinting, in words, means that an antenna pattern points to $\theta_0 + \Delta\theta$ at frequency $f_0 + \Delta f$ instead of θ_0 , which was the pointing direction at frequency f_0 . With figure 1, we see that this might also be interpreted as a reduction of the gain in the

direction θ_0 , limiting the usable bandwidth of the system. The goal of this paper is to quantify beam squinting, i.e. express $\Delta\theta$ as a function of Δf . To clarify the approach in our work compared to previous work, figure 2 shows the phase-frequency characteristics of an ideal phase-shifter, an ideal time-delay and a practical time-delay circuit used in a frequency band centred on f_0 . In [1] a beam squinting formula has been derived for phased array systems realized with ideal phase-shifters. Also, in [4] a beam squinting formula has been derived for phased-array systems with ideal time-delays and phase-shifters used at different hierarchical levels. Here we will derive a beam squinting formula based on the tangent line in Figure 2, which models practical time delay non-ideality using the criterion $f_{\varphi=0}$ [6]. We extract $f_{\varphi=0}$ from the phase transfer function of a practical (non-ideal) delay cell to quantify variations of the delay with frequency centred on f_0 .

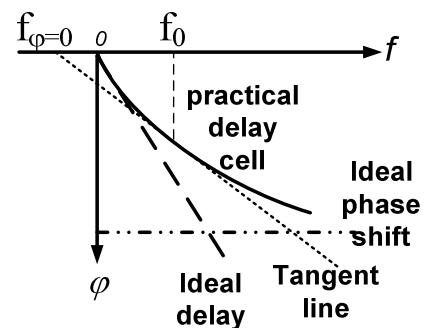

Figure 2. Phase-frequency characteristic of a practical delay circuit, its tangent approximation line in comparison to an ideal delay, and an ideal phase-shifter circuit

Criterion $f_{\varphi=0}$ can be used for arbitrary delay cells, for example it fits well to g_m -RC and LC delay cells. The main reason for its use, however, is that it is proven to be invariant for cascaded cells [6] which allows establishing a direct relationship between phased array system specifications and the delay cell requirements.

The relation between $\Delta\theta$ and Δf is established in section II. With the help of a two-term Taylor approximation, formulated

in section III, we develop the beam squinting relation in the presence of time-delay nonlinearities in section IV. Finally the relation between system specifications and delay-element requirements is illustrated in section V after which it is applied to a typical example in section VI.

II. RELATION BETWEEN $\Delta\theta$ AND Δf

Figure 3 shows a typical linear phased array where d is the distance between any two adjacent antenna elements and $-\pi/2 < \theta < \pi/2$ is the spatial direction of the beam with respect to bore sight. D_0, \dots, D_{N-1} are the delay blocks after the antenna elements.

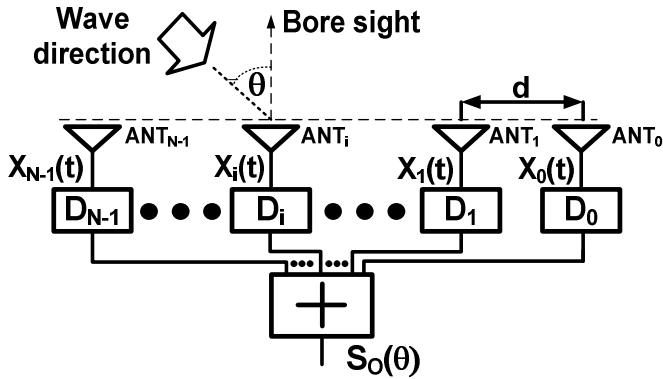

Figure 3. Linear phased array antenna system with equally spaced antennas

Equation 2 defines the beam pattern $S_{o,pattern}(\theta)$ [7]:

$$S_{o,pattern}(\theta) = \frac{S_e(\theta)}{\sum_{i=0}^{N-1} \alpha_i} \sum_{i=0}^{N-1} \alpha_i e^{j2\pi f \left(i \frac{d}{c} \sin \theta - i \frac{d}{c} \sin \theta_0 \right)} \quad (2)$$

$S_e(\theta)$ is the antenna element pattern, α_i is the ‘‘amplitude tapering factor’’ of the i^{th} antenna route, c is the speed of light and θ_0 the direction of the main beam. Equation 3 shows the values of delay in delay blocks to have beam direction toward θ_0 :

$$t_{D_i} = i \cdot \frac{d}{c} \sin \theta_0 \quad ; \quad i = 0, \dots, N - 1 \quad (3)$$

A general realization method for D_0, \dots, D_{N-1} is by cascading different numbers of identical delay cells (figure 4). Delay cells for instance are realized by g_m -RC or LC circuits.

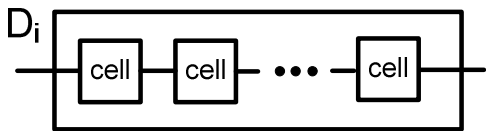

Figure 4. Delay D_i synthesized from cascaded delay cells.

Equation 3 reveals that the delay of each delay block (D_0, \dots, D_{N-1}) is an integer multiple of $t_{D_1} = \left(\frac{d}{c} \sin \theta_0 \right)$. For

practical implementations: $t_{D_1} = t_{D_1}(f)$. By substituting $t_{D_1}(f) = \left(\frac{d}{c} \sin \theta_0 \right)$ in (2) we get:

$$S_{o,pattern}(\theta) = \frac{S_e(\theta)}{\sum_{i=0}^{N-1} \alpha_i} \sum_{i=0}^{N-1} \alpha_i e^{j2\pi f i \left(\frac{d}{c} \sin \theta - t_{D_1}(f) \right)} \quad (4)$$

The beam direction at frequency f is the value of θ that results in a maximum value of $S_{o,pattern}(\theta)$, which happens when all antenna contributions align up in phase, i.e. [7]:

$$\frac{d}{c} \sin \theta - t_{D_1}(f) = 0 \quad (5)$$

Suppose that at f_0 the beam direction is toward θ_0 , then:

$$\frac{d}{c} \sin \theta_0 - t_{D_1}(f_0) = 0 \quad (6)$$

If the operating frequency varies from f_0 to $f_0 + \Delta f$, then due to beam squinting the beam points towards direction $\theta_0 + \Delta\theta$. Substituting $f_0 + \Delta f$ and $\theta_0 + \Delta\theta$ in (5) renders:

$$\frac{d}{c} \sin(\theta_0 + \Delta\theta) - t_{D_1}(f_0 + \Delta f) = 0 \quad (7)$$

The beam squinting formula $\Delta\theta = \Delta\theta(\Delta f)$ can be derived by solving (7). However, because terms at the left side of (7) are nonlinear functions of $\theta_0 + \Delta\theta$ and $f_0 + \Delta f$, its analytical solution can be complicated which is inconvenient for design purposes. Therefore, we will approximate both nonlinear terms of (7) by a linear 2-term Taylor series approximation.

III. $f_{\varphi=0}$: A CRITERION FOR DELAY VERSUS FREQUENCY VARIATIONS

In order to linearly approximate $t_{D_1}(f_0 + \Delta f)$, we use a recently introduced criterion $f_{\varphi=0}$ [6] to quantify delay variations over frequency. The fact that $f_{\varphi=0}$ is not affected by cascading of identical cells makes it particularly attractive for designing cascaded delay circuits as in figure 4.

Figure 5, shows the $f_{\varphi=0}$ for the phase transfer function of $t_{D_1}(f)$. At operating frequency of f_0 , $f_{\varphi=0,D_1}$ is defined as the cross-point of the frequency axis with the tangent line L to the phase characteristic at $(f_0, \varphi_{D_1}(f_0))$.

By inspection of figure 5 we can write $f_{\varphi=0,D_1}$ as [6]:

$$f_{\varphi=0,D_1} = f_0 - \frac{\varphi_{D_1}(f_0)}{\left. \frac{\partial \varphi_{D_1}(f)}{\partial f} \right|_{f_0}} \quad (8)$$

The delay of the delay block D_1 at frequency f_0 is equal to $t_{D_1}(f_0) = -\varphi_{D_1}(f_0) / (2\pi f_0)$.

For finding the delay at $f_0 + \Delta f$, we linearly approximate the curve with its tangent (L line) (equation 9) [6].

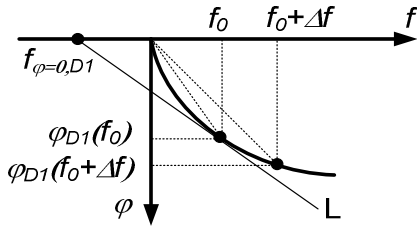

Figure 5. $f_{\varphi=0}$ for delay D_1 that is operating at f_0

$$t_{D1}(f_0 + \Delta f) \approx t_{D1}(f_0) \left(1 + \frac{\frac{f_{\varphi=0,D1}}{f_0} \Delta f}{1 - \frac{f_{\varphi=0,D1}}{f_0}} \right) \quad (9)$$

As it is shown in figure 4, D_1 is synthesized with cascaded identical delay cells and $f_{\varphi=0,cell}$ for each delay cell is[6]:

$$f_{\varphi=0,cell} = f_0 - \frac{\varphi_{cell}(f_0)}{\left. \frac{\partial \varphi_{cell}(f)}{\partial f} \right|_{f_0}} \quad (10)$$

It can be proven that $f_{\varphi=0,D1} = f_{\varphi=0,cell}$ [6], which is illustrated in figure 6. Substituting $f_{\varphi=0,cell}$ in equation 9, we find:

$$t_{D1}(f_0 + \Delta f) \approx t_{D1}(f_0) \left(1 + \frac{\frac{f_{\varphi=0,cell}}{f_0} \Delta f}{1 - \frac{f_{\varphi=0,cell}}{f_0}} \right) \quad (11)$$

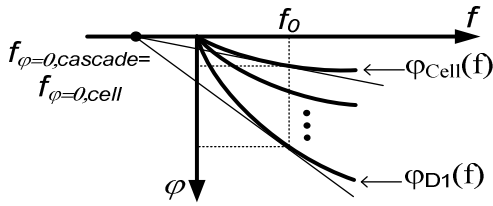

Figure 6. Cascading identical delay cells does not affect $f_{\varphi=0}$

Equation 11 shows that we can estimate delay of $t_{D1}(f_0 + \Delta f)$ via $t_{D1}(f_0)$ and also $f_{\varphi=0}$ of its constituent delay cells.

In the next section this result is used to derive $\Delta\theta(\Delta f)$.

IV. BEAM SQUINTING FORMULA

We will now use the linear approximation derived in the previous section to derive the beam squint formula. Substituting equation (11) in (7) and some rewriting gives:

$$\frac{d}{c} [\sin\theta_0 + \Delta\theta \cdot \cos\theta_0] - t_{D1}(f_0) \left(1 + \frac{\frac{f_{\varphi=0,cell}}{f_0} \Delta f}{1 - \frac{f_{\varphi=0,cell}}{f_0}} \right) = 0 \quad (12)$$

Rearranging terms of equation 12 results in:

$$\left[\frac{d}{c} \sin\theta_0 - t_{D1}(f_0) \right] + \left[\frac{d}{c} \cdot \Delta\theta \cdot \cos\theta_0 - t_{D1}(f_0) \frac{\frac{f_{\varphi=0,cell}}{f_0} \Delta f}{1 - \frac{f_{\varphi=0,cell}}{f_0}} \right] = 0 \quad (13)$$

The part between the first brackets is zero according to (6). Therefore the remaining part of (13) must be equal to zero too, which allows to easily solving $\Delta\theta$ as a function of Δf :

$$\Delta\theta = \frac{1}{f_0} \frac{c}{d} \frac{t_{D1}(f_0)}{\cos\theta_0} \frac{\frac{f_{\varphi=0,cell}}{f_0}}{1 - \frac{f_{\varphi=0,cell}}{f_0}} \cdot \Delta f \quad (14)$$

This can be further simplified, substituting $t_{D1}(f_0)$ from (6) in (14). The result is (15) or the beam squinting formula:

$$\Delta\theta = \frac{\tan\theta_0}{f_0} \frac{\frac{f_{\varphi=0,cell}}{f_0}}{1 - \frac{f_{\varphi=0,cell}}{f_0}} \cdot \Delta f \quad (15)$$

Thus we see that $f_{\varphi=0,cell}/f_0$ is crucial for beam squint estimation. For a phased array realized by ideal time-delay cells, $f_{\varphi=0,cell}$ is equal to zero and we find indeed zero squinting ($=0$). For a phased array realized by ideal phase-shifters, $f_{\varphi=0,cell}$ is equal to $-\infty$ rendering the result from [1]:

$$\Delta\theta = -\frac{\tan\theta_0}{f_0} \Delta f \quad (16)$$

In the next section as an example $f_{\varphi=0,cell}$ will be derived for an all-pass delay cell.

V. BEAM SQUINTING WITH ALL-PASS DELAY CELLS.

One possibility is to realize a time-delay cell by implementing a first order all-pass filter. The ideal transfer function of this all-pass filter is given as:

$$H_{all-pass}(f) = \frac{(1 - j \frac{f}{f_p})}{(1 + j \frac{f}{f_p})} \quad (17)$$

We use equation (10) to find a normalized graph of the $f_{\varphi=0,cell}$ versus f_0/f_p . Normalization gives us a generalized curve to be used for 1st order delay cells with any value of the pole frequency (f_p) and the operating frequency (f_0). The curve helps to find an f_p for the delay cell to keep the beam squinting below a requested range. The phase transfer function of the 1st order all-pass cell is:

$$\varphi_{all-pass}(f) = -2 \tan^{-1} \left(\frac{f}{f_p} \right) \quad (18)$$

This leads to amount of the delay per all-pass cell at f_0 :

$$t_{all-pass}(f_0) = \frac{2 \tan^{-1} \left(\frac{f_0}{f_p} \right)}{2\pi f_0} \quad (19)$$

Substitution of (18) in (10) and normalization for f_0 results equation (20) which its graph is figure 7.

$$\frac{f_{\varphi=0,all-pass}}{f_0} = 1 - \tan \left(\frac{f_0}{f_p} \right) \left[\frac{f_0}{f_p} + \frac{f_p}{f_0} \right] \quad (20)$$

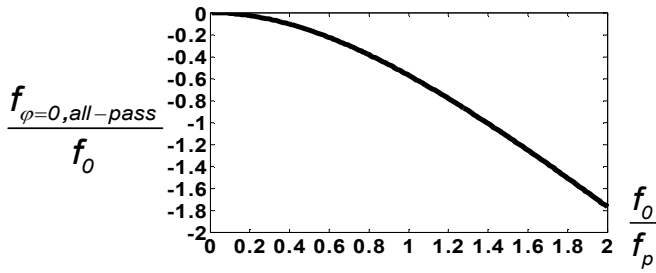

Figure7. Normalized $f_{\phi=0}$ versus f_0 curve for all-pass cells

This graph is used to find minimum value of f_p of a 1st order all-pass delay cell that satisfies a certain permitted amount of the beam squinting. Suppose an amount of $\Delta\theta/\Delta f$ for the phased array antenna is permitted, then via (15), $f_{\phi=0,cell}/f_0$ is found and then via the graph of the figure 7, f_0/f_p and consequently the minimum value of f_p can be found.

VI. EXAMPLE

We show how we can find the minimum required pole frequency (f_p) of an all-pass delay cell starting from a beam squinting specification and verify the design by simulations. We aim to keep the beam squinting in a defined range. As an example, we assume a linear phased array antenna system with the following characteristics: $N=100$ antenna elements, operating frequency $f_0=10\text{GHz}$, element distance $d=\lambda/2=1.5\text{cm}$ and a maximum steering angle $\theta_0=60^\circ$. Assume furthermore that an absolute beam squinting per frequency deviation ($\Delta\theta/\Delta f$) of less than $3^\circ/\text{GHz}$ is required:

$f_{\phi=0,all-pass}/f_0$ is found by substituting $\Delta\theta/\Delta f$, f_0 and θ_0 in beam squinting formula (15). The result is: $f_{\phi=0,all-pass}/f_0 > -0.43$. Substitution of $f_{\phi=0,all-pass}/f_0 > -0.43$ in graph of figure 7 results $f_0/f_p < 0.85$. Because $f_0=10\text{GHz}$, then we will find f_p of the all-pass delay cell which is $f_p > 11.8\text{GHz}$.

Therefore, to obtain a beam squinting less than $3^\circ/\text{GHz}$, the all-pass delay cell which we use in the phased array must have a pole frequency (f_p) bigger than 11.8GHz . The delay of the cell is found from equation 19 which is $t_{all-pass}=21.4$ ps. The maximum required delay for the phased array (Delay of D_{N-1} block of figure 3) is found by substituting values of $i=N-1=99$, $d=\lambda/2=1.5\text{cm}$, $c=\text{light speed}$ and $\theta_0=60^\circ$ in equation 3. The result is: $t_{D99}=2143\text{psec}$, Maximum number of cascaded delay cells to synthesize t_{D99} is found from $t_{D99}/t_{all-pass}$ which is: 100.14. Therefore 101 cascaded all-pass delay cells are required for synthesizing D_{99} delay block in the phased array antenna system.

Finally, to verify the precision of our method, we simulate the phased array with delay blocks as synthesized above, to check if the beam squinting is in the requested range. Table 1 compares the simulated and required beam squinting for different frequency offsets from $f_0=10\text{GHz}$. The error is calculated via: $\text{Error}=(\Delta\theta_{\text{Simulated}}-\Delta\theta_{\text{Required}})$. It shows that up to

15 GHz (50% offset from f_0), the absolute amount of the error remains less than 14% of $\Delta\theta_{\text{Required}}$. This shows that via our method we can design delay cells to keep the beam squinting in the requested range.

Table 1

Comparison between the simulated and the required beam squinting

| | $f_0=10$ GHz | $\Delta f=0.1$ GHz | $\Delta f=0.5$ GHz | $\Delta f=1$ GHz | $\Delta f=2$ GHz | $\Delta f=5$ GHz |
|-----------|----------------------|-----------------------|-----------------------|---------------------|---------------------|---------------------|
| Simulated | $\Delta\theta^\circ$ | 0.34 | 1.67 | 3.23 | 6.14 | 13.4 |
| Required | $\Delta\theta^\circ$ | 0.3 | 1.5 | 3 | 6 | 15 |
| Error | $^\circ$ | 0.04 | 0.17 | 0.23 | 0.14 | -1.6 |

VII. CONCLUSION

A general formula was derived to estimate beam squinting in phased array antenna systems. This formula is particularly useful to estimate beam squinting of wide band (time-delay based) phased array antenna systems. To estimate beam squinting we first calculate the criterion ($f_{\phi=0,cell}$) from the phase transfer function of the delay cell. Then find the beam squinting via the beam squinting formula with $f_{\phi=0,cell}$ as a parameter.

Also the beam squinting formula can be used to estimate the amount of $f_{\phi=0,cell}$ to keep the beam squinting in a permitted range. We designed a phased array with 1st order all-pass delay cells via this method. The method is suitable for non-ideal time-delay elements as well as for non-ideal phase-shifters, or any other element where the phase transfer can be approximated linearly.

REFERENCES

- [1] R.J.Mailloux, "Phased array antenna handbook", Artech house, 2007.
- [2] Nicholas Fourikis, "Advanced Array Systems, Applications and RF technology", Academic Press, 2000.
- [3] Paramesh, J, "A four-antenna receiver in 90-nm CMOS for beamforming and spatial diversity", IEEE Journal of Solid-State Circuits (JSSC), Vol: 40, no: 12, pp. 2515 - 2524, Dec. 2005.
- [4] Yajima, M, "Beam Pointing Error of Wideband Planar Phased Array", IEEE International Conference on Communications, pp: 4161-4166, 2006.
- [5] Ta-Shun Chu, "An Integrated Ultra-Wideband Timed Array Receiver in 0.13 μm CMOS Using a Path-Sharing True Time Delay Architecture", Journal of Solid-State Circuits (JSSC), Vol: 42, no: 12, pp. 2834-2850, 2007.
- [6] Garakoui, S., K., "Time delay circuits: A quality criterion for delay variations versus frequency," International Symposium on Circuits and Systems, pp.4281-4284, 2010.
- [7] Hubegt Visser, "Array and Phased Array Antenna Basics", Wiley 2005.
- [8] Frank Ellinger, "Radio Frequency integrated circuits and technologies", Springer 2007.