

Shad-o-Scan™ 3001/4501 Pre-Datasheet

CMOS X-ray Detectors



Key Features

- » Radiation hardened CMOS technology ensures long lifetime
- » 14-bit digital real-time output
- » 99 μm pixel size
- » 5G Ethernet interface
- » Energy range 10-225 kV
- » High speed (up to 35 m/min)
- » Low power consumption (no active cooling required)
- » On-board pixel correction
- » Ready-to-run software and drivers

Typical Applications

- » Non-destructive testing (NDT)
- » Electronics inspection (2D/3D)
- » Food inspection
- » Scientific imaging

Shad-o-Scan Scanning X-Ray Detectors: Ultimate Sensitivity and Resolution

Overview

With the release of the Shad-o-Scan 3001/4501, Teledyne DALSA introduces a new family of scanning x-ray detectors specifically designed for the challenging requirements of high-performance industrial and scientific x-ray scanning applications. The Shad-o-Scan detectors leverage Teledyne DALSA's advanced CMOS image sensing technology, which delivers high-speed, low-dose x-ray images and yields higher image quality than other scanning devices.

The Shad-o-Scan xx01 product family consists of 2 models up to 45 cm, a 99 μm pixel size, a high-speed, real-time image transfer via a 5G Ethernet interface, 14 bits digitization and SDK's, drivers and programming support. The camera interface allows easy access to features such as adjusting the frame rate, single and multiple frame acquisitions, and control of advanced timing modes.

Software

Each Shad-o-Scan detector ships with Teledyne DALSA's CamExpert software and an Ethernet driver. The software is compatible with Windows 7, 8 and 10. Check with your sales representative for compatibility with other Windows versions or with the Linux operating system. The detector can be connected on a network, but for optimal performance a dedicated network adapter is highly recommended.

For writing custom applications to acquire images from the camera, we recommend using **Teledyne DALSA's Sapera Essential or the Sapera LT SDK** (free download at <http://www.teledynedalsa.com>).



Specifications

Detector Specifications	Shad-o-Scan 3001	Shad-o-Scan 4501
Active Area Length	304 mm	456 mm
Resolution	3072 x 64 pixels	4608 x 64 pixels
Pixel Size	99 μm	
Maximum Scanning speed ¹	Up to 35 m/min	
Pixel Binning Mode	1x1 / 1x2 / 2x2 / 4x4	
Digitalization	14 bits (16384 levels)	
Image Lag	<0.1%	
Non-Linearity (10..90%FS)	<1.5%	
Typical Dynamic Range	74 dB	
X-ray Sensor Lifetime Dose	> 10 kGy	
Camera Specifications		
Supply Voltage (DC)	+15 V	
Power Consumption (max)	20 W	
Data and Control Interface	5GigE Ethernet	
Trigger Connector	TTL	
On-board Calibration	Yes	
General Specifications		
Operating Temperature	0 to 40°C	
Storage Temperature	-10 to +55°C	
Humidity (non-condensing)	10 to 80% R.H.	
Weight ²	< 5 kg	
Ingress Protection Class	IP69K	

(1) 16 lines in 1x2 binned mode read-out

(2) depends on detector model

Resolution & Sensitivity

The Shad-o-Scan detectors are designed to work with x-ray sources operating at a wide range of beam energy settings. X-ray energies as low as 10-15 kV can be detected. The cameras can be used with x-ray energies as high as 225 kV, although we recommend the use of additional shielding and/or collimation at higher energies in order to protect the sensor element and electronics from damage.

The pixel spacing determines the limiting resolution of the sensor. The actual Modulation Transfer Function (MTF) of the detector depends on the type of scintillator that is installed, as well as the binning mode selected. A thicker phosphor screen will produce more signal, but at the expense of high-frequency contrast. Typical MTF curves for the standard scintillator option is shown in the graph below.

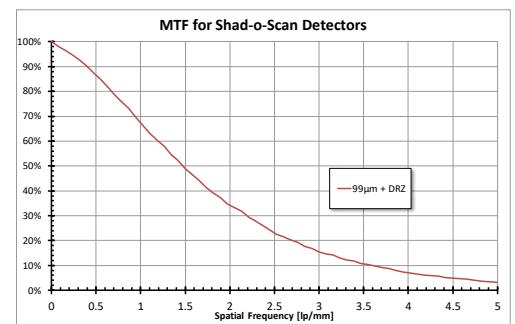

Typical Sensitivity ¹ [ADU/μGy]	50 kVp	80 kVp
DRZ-Std	9.7	13.7

(1) W target, 2mm glass window, no filtration

Mechanical Drawing 3001 Model

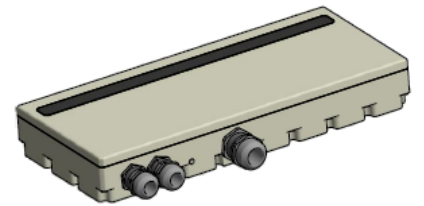
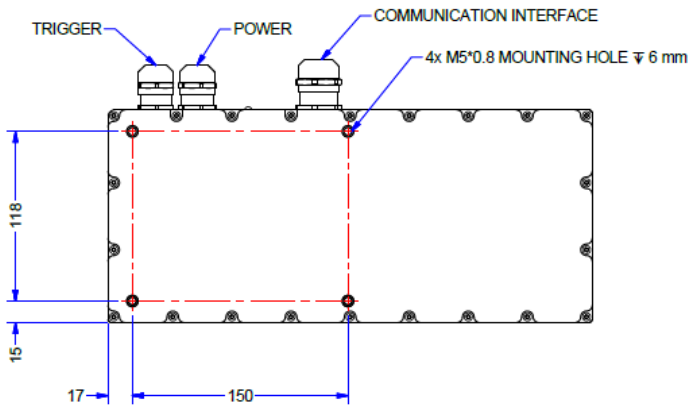
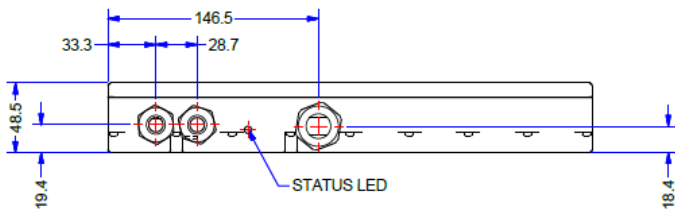
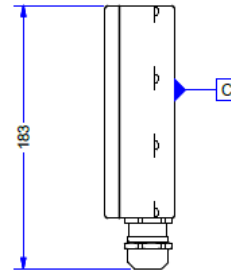
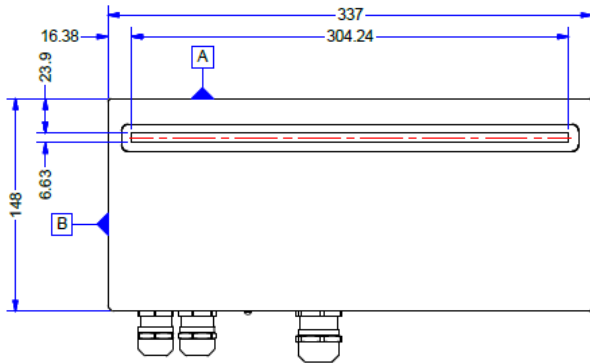

Mechanical Drawing 4501 Model

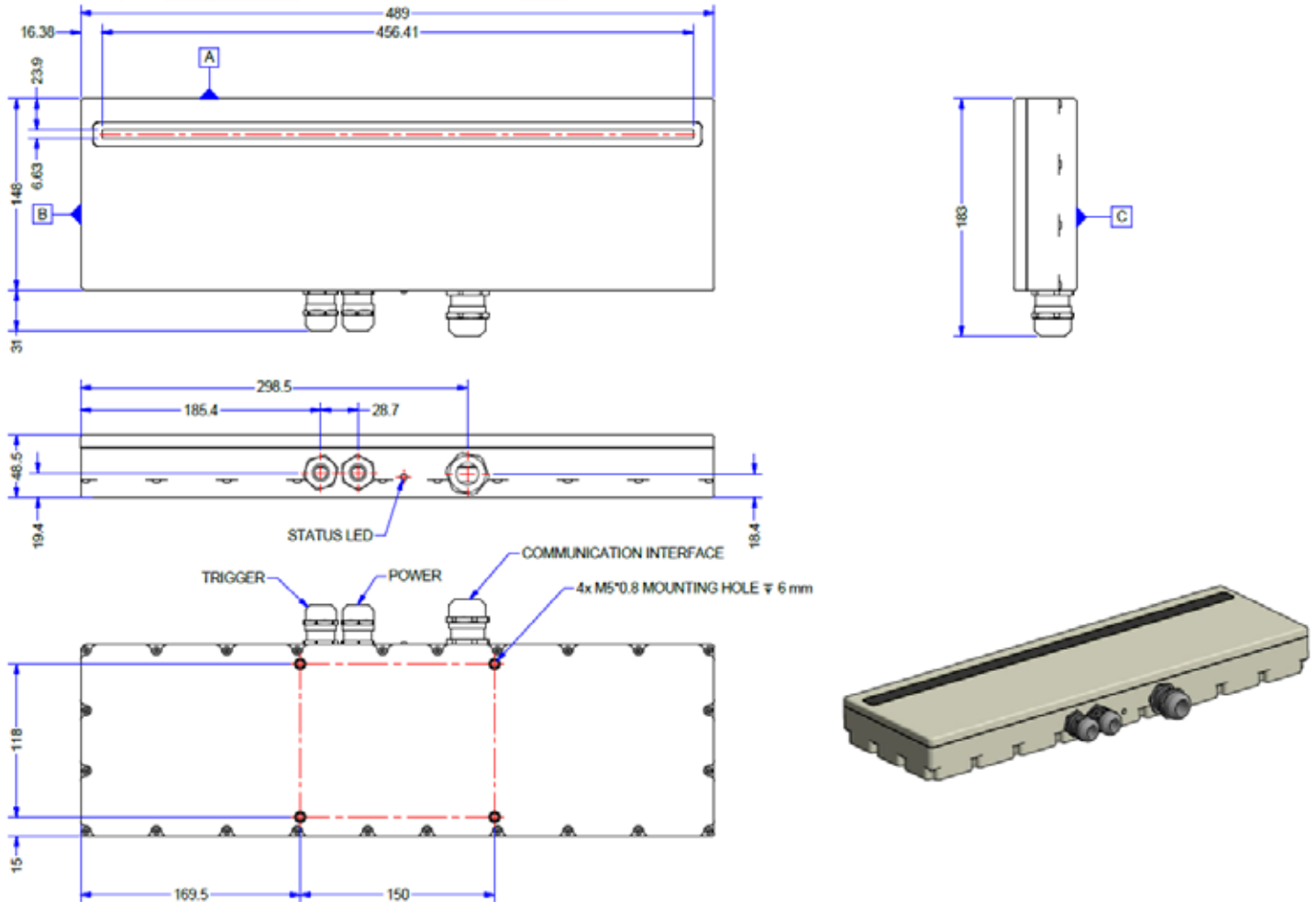

Ordering Information

All Shad-o-Scan detectors are shipped with a universal input power supply (90-264V, 50-60Hz) and a power cable. Please contact your nearest sales representative for additional options.

P/N	Description
SB1661-02	Shad-o-Scan 3001 with DRZ-Std Scintillator
SB1671-02	Shad-o-Scan 4501 with DRZ-Std Scintillator

Contact Information

Teledyne Rad-ikon Imaging
765 Sycamore Drive, Milpitas, CA 95035 USA

Americas

Waterloo, ON
+1 519-886-6000
sales.sensors@teledynedalsa.com

Europe

Eindhoven, The Netherlands
+31 40-259-9000
sales.sensors@teledynedalsa.com

Asia Pacific

Tokyo, Japan
+81 3-5960-6353
sales.asia@teledynedalsa.com

Shanghai, China
+86 21-3368-0027
sales.asia@teledynedalsa.com